

## RARE DECAYS: THEORY VS. EXPERIMENTS

GINO ISIDORI

*Theory Division, CERN, CH-1211 Geneva 23, Switzerland*

*INFN, Laboratori Nazionali di Frascati, Via E. Fermi 40, I-00044 Frascati, Italy*

*E-mail: Gino.Isidori@cern.ch*

We present an overview of rare  $K$ ,  $D$  and  $B$  decays. Particular attention is devoted to those flavour-changing neutral-current processes of  $K$  and  $B$  mesons that offer the possibility of new significant tests of the Standard Model. The sensitivity of these modes to physics beyond the Standard Model and the status of their experimental study are also discussed.

### 1 Introduction

Why are we interested in rare decays? As a general rule, rare processes are particularly interesting when their suppression is associated to some, hopefully broken, conservation law. The most significant examples in this respect are proton decay and  $\mu \rightarrow e\gamma$ : processes completely forbidden within the Standard Model (SM) that, if observed, would represent an invaluable step forward in our understanding of fundamental interactions.

Conservation laws that so far appear unbroken can also be tested by means of heavy mesons. However, the most interesting perspectives in rare  $K$ ,  $D$  and  $B$  decays are probably those opened by precision studies of flavour-changing neutral currents (FCNCs), or transitions of the type

$$q_i \rightarrow q_j + \begin{cases} \nu\bar{\nu} \\ \ell^+\ell^- \\ \gamma \end{cases} \quad (1)$$

These processes are not completely forbidden within the SM, but are generated only at the quantum level because of the Glashow–Iliopoulos–Maiani (GIM) mechanism,<sup>1</sup> and are additionally suppressed by the hierarchical structure<sup>2</sup> of the Cabibbo–Kobayashi–Maskawa (CKM) matrix.<sup>3</sup> FCNCs are thus particularly well suited to study the dynamics of quark-flavour mixing, within and beyond the SM. As a matter of fact, some of these processes (such as  $K_L \rightarrow \mu^+\mu^-$ ) have played an important role in the historical for-

mulation of the SM.

As discussed by many speakers at this conference, the CKM mechanism of quark-flavour mixing is in good agreement with all data available at present. The recent measurements of CP violation in the  $B_d$  system<sup>4,5</sup> add a new piece of information that fits remarkably within the overall picture.<sup>6</sup> One could therefore doubt about the need for new tests of the SM in the sector of (quark) flavour physics. However, there are at least two arguments why the present status cannot be considered conclusive and a deeper study of FCNCs is very useful:

- The information used at present to constrain the CKM matrix and, in particular, the unitarity triangle,<sup>6</sup> is obtained only from charged currents (i.e. from tree-level amplitudes) and  $\Delta F = 2$  loop-induced processes (see Fig. 1). In principle, rare  $K$  and  $B$  decays mediated by FCNCs could also be used to extract indirect information on the unitarity triangle. However, either because of experimental difficulties or because of theoretical problems, the quality of this information is very poor at present, with at least  $\mathcal{O}(100\%)$  uncertainties. Since new physics could affect in a very different way  $\Delta F = 2$  and  $\Delta F = 1$  loop-induced amplitudes [e.g. with  $\mathcal{O}(100\%)$  effects in the former and  $\mathcal{O}(10\%)$  in the latter], it is mandatory to improve the quality of the FCNC information.

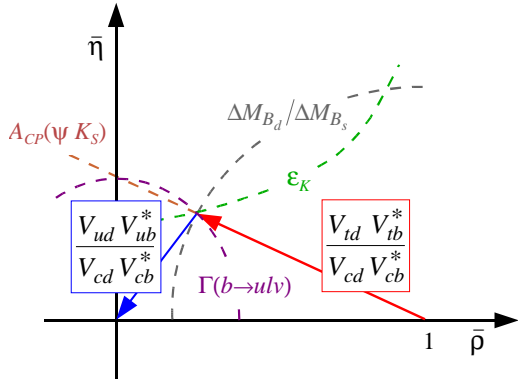

Figure 1. Definition of the reduced CKM unitarity triangle,<sup>7</sup> with the indication of the most significant experimental constraints currently available.

- Most of the observables used in the present fits, such as  $\epsilon_K$ ,  $\Gamma(b \rightarrow ul\bar{\nu})$  or  $\Delta M_{B_d}$ , suffer from irreducible theoretical errors at the 10% level (or above). In the perspective of reaching a high degree of precision, it would be desirable to base these fits only on observables with theoretical errors at the percent level (or below), such as the CP asymmetry in  $B \rightarrow J/\Psi K_S$ . As we shall see, a few rare  $K$  and  $B$  decays could offer this opportunity.

Motivated by the above arguments, most of this talk is devoted to  $K$  and  $B$  decays that offer the possibility of precision FCNC studies. In particular,  $K \rightarrow \pi\nu\bar{\nu}$  decays, the so-called *golden modes* of  $K$  physics, are discussed in Section 2; in this section we shall also make some general remarks about non-standard contributions to FCNCs. Rare  $K$  decays with a charged lepton pair in the final state are discussed in Section 3. A general discussion about inclusive FCNC  $\Delta B = 1$  transitions is presented in Section 4. Section 5 is devoted to  $B \rightarrow X_{s,d}\gamma$ , whereas inclusive and exclusive  $B$  decays with a charged lepton pair in the final state are analysed in Section 6. A brief discussion about other processes, including  $D$  decays and lepton-flavour vio-

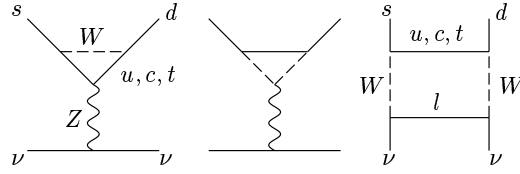

Figure 2. One-loop diagrams contributing to the  $s \rightarrow d\nu\bar{\nu}$  transition.

lating modes is presented in Section 7. The overall picture is summarized in the Section 8.

## 2 FCNCs in $K$ decays: the golden $K \rightarrow \pi\nu\bar{\nu}$ modes

The  $s \rightarrow d\nu\bar{\nu}$  transition is one of the rare examples of weak processes whose leading contribution starts at  $\mathcal{O}(G_F^2)$ . At the one-loop level it receives contributions only from  $Z$ -penguin and  $W$ -box diagrams, as shown in Fig. 2, or from pure quantum electroweak effects. Separating the contributions to the one-loop amplitude according to the intermediate up-type quark running inside the loop, we can write

$$\begin{aligned} \mathcal{A}(s \rightarrow d\nu\bar{\nu}) &= \sum_{q=u,c,t} V_{qs}^* V_{qd} \mathcal{A}_q \\ &\sim \begin{cases} \mathcal{O}(\lambda^5 m_t^2) + i\mathcal{O}(\lambda^5 m_t^2) & (q=t) \\ \mathcal{O}(\lambda m_c^2) + i\mathcal{O}(\lambda^5 m_c^2) & (q=c) \\ \mathcal{O}(\lambda \Lambda_{\text{QCD}}^2) & (q=u) \end{cases} \quad (2) \end{aligned}$$

where  $V_{ij}$  denote the elements of the CKM matrix. The hierarchy of these elements would favour up- and charm-quark contributions; however, the *hard* GIM mechanism of the perturbative calculation implies  $\mathcal{A}_q \sim m_q^2/M_W^2$ , leading to a completely different scenario. As shown on the r.h.s. of (2), where we have employed the standard CKM phase convention ( $\Im V_{us} = \Im V_{ud} = 0$ ) and expanded the  $V_{ij}$  in powers of the Cabibbo angle ( $\lambda = 0.22$ ),<sup>2</sup> the top-quark contribution

dominates both real and imaginary parts.<sup>a</sup> This structure implies several interesting consequences for  $\mathcal{A}(s \rightarrow d\nu\bar{\nu})$ :

- a. it is dominated by short-distance dynamics, therefore its QCD corrections are small and calculable in perturbation theory;
- b. it is very sensitive to  $V_{td}$ , which is one of the less constrained CKM matrix elements;
- c. it is likely to have a large CP-violating phase;
- d. it is very suppressed within the SM and thus very sensitive to possible new sources of quark-flavour mixing.

Short-distance contributions to  $\mathcal{A}(s \rightarrow d\nu\bar{\nu})$ , within the SM, can efficiently be described by means of a single effective dimension-6 operator:

$$Q_L^{\nu} = \bar{s}_L \gamma^{\mu} d_L \bar{\nu}_L \gamma_{\mu} \nu_L . \quad (3)$$

Both next-to-leading-order (NLO) QCD corrections<sup>8,9,10</sup> and  $\mathcal{O}(G_F^3 m_t^4)$  electroweak corrections<sup>11</sup> to the Wilson coefficient of  $Q_L^{\nu}$  have been calculated, leading to a very precise description of the partonic amplitude. In addition, the simple structure of  $Q_L^{\nu}$  has two important advantages:

- The relation between partonic and hadronic amplitudes is quite accurate, since hadronic matrix elements of the  $\bar{s}\gamma^{\mu}d$  current between a kaon and a pion are related by isospin symmetry to those entering  $K_{l3}$  decays, which are experimentally well known.
- The lepton pair is produced in a state of definite CP and angular momentum, implying that the leading SM contribution to  $K_L \rightarrow \pi^0\nu\bar{\nu}$  is CP-violating.

<sup>a</sup> The  $\Lambda_{\text{QCD}}^2$  factor in the last line of (2) follows from a naive estimate of long-distance effects.

## 2.1 SM uncertainties

The dominant theoretical error in estimating the  $K^+ \rightarrow \pi^+\nu\bar{\nu}$  rate is due to the subleading, but non-negligible charm contribution. Perturbative NNLO corrections in the charm sector have been estimated<sup>10</sup> to induce an error in the total rate of around 10%, which can be translated into a 5% error in the determination of  $|V_{td}|$  from  $\mathcal{B}(K^+ \rightarrow \pi^+\nu\bar{\nu})$ . Recently, also non-perturbative effects introduced by the integration over charmed degrees of freedom have been analysed<sup>12</sup> and turns out to be within the error of NNLO terms. Finally, genuine long-distance effects associated to light-quark loops have been shown<sup>13</sup> to be negligible with respect to the uncertainties from the charm sector.

The case of  $K_L \rightarrow \pi^0\nu\bar{\nu}$  is even cleaner from the theoretical point of view.<sup>14</sup> Because of the CP structure, only the imaginary parts in (2) –where the charm contribution is absolutely negligible– contribute to  $\mathcal{A}(K_L \rightarrow \pi^0\nu\bar{\nu})$ . Thus the dominant direct-CP-violating component of  $\mathcal{A}(K_L \rightarrow \pi^0\nu\bar{\nu})$  is completely saturated by the top contribution, where QCD corrections are suppressed and rapidly convergent. Intermediate and long-distance effects in this process are confined only to the indirect-CP-violating contribution<sup>15</sup> and to the CP-conserving one,<sup>16</sup> which are both extremely small. Taking into account the isospin-breaking corrections to the hadronic matrix element,<sup>17</sup> we can write an expression for the  $K_L \rightarrow \pi^0\nu\bar{\nu}$  rate in terms of short-distance parameters, namely<sup>10,15</sup>

$$\mathcal{B}(K_L \rightarrow \pi^0\nu\bar{\nu})_{\text{SM}} = 4.16 \times 10^{-10} \times \left[ \frac{\bar{m}_t(m_t)}{167 \text{ GeV}} \right]^{2.30} \left[ \frac{\Im(V_{ts}^* V_{td})}{\lambda^5} \right]^2 , \quad (4)$$

which has a theoretical error below 3%.

The high accuracy of the theoretical predictions of  $\mathcal{B}(K^+ \rightarrow \pi^+\nu\bar{\nu})$  and  $\mathcal{B}(K_L \rightarrow \pi^0\nu\bar{\nu})$  in terms of modulus and phase of  $\lambda_t = V_{ts}^* V_{td}$  clearly offers the possibility of very interesting tests of the CKM mechanism. A

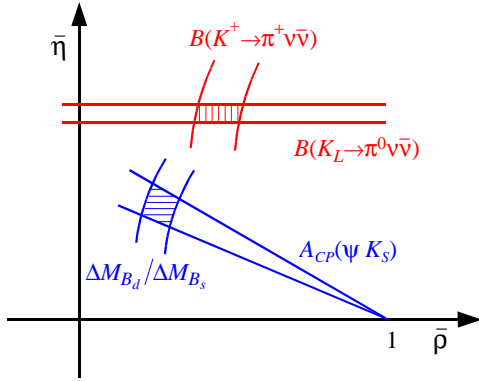

Figure 3. Possible future comparison between  $K \rightarrow \pi\nu\bar{\nu}$  rates and clean  $B$ -physics observables (in the presence of new physics).<sup>18</sup>

measurement of both channels would provide two independent pieces of information on the unitarity triangle, or a determination of  $\bar{\rho}$  and  $\bar{\eta}$ . In principle, as shown in Fig. 3, very precise and highly non-trivial tests of the CKM mechanism could be obtained by the comparison of the following two sets of data:<sup>15</sup> the two  $K \rightarrow \pi\nu\bar{\nu}$  rates on one side, the ratio  $\Delta M_{B_d}/\Delta M_{B_s}$  and the time-dependent CP asymmetry in  $B \rightarrow J/\Psi K_S$  on the other side. The two sets are both determined by very different loop amplitudes ( $\Delta S = 1$  FCNCs and  $\Delta B = 2$  mixing) and both suffer of very small theoretical errors.

At present the SM predictions of the two  $K \rightarrow \pi\nu\bar{\nu}$  rates are not extremely precise owing to the limited knowledge of  $\lambda_t$ . Taking into account all the indirect constraints, the allowed range is given by<sup>10</sup>

$$\mathcal{B}(K^+ \rightarrow \pi^+ \nu\bar{\nu})_{\text{SM}} = (0.8 \pm 0.3) \times 10^{-10} \quad (5)$$

$$\mathcal{B}(K_L \rightarrow \pi^0 \nu\bar{\nu})_{\text{SM}} = (2.8 \pm 1.1) \times 10^{-11} \quad (6)$$

## 2.2 Beyond the SM: general considerations

As far as we are interested only in rare FCNC transitions, we can roughly distinguish the extensions of the SM into two big categories:

- *Models with minimal flavour violation*, or models where the only source of quark-flavour mixing is the CKM matrix (e.g. the two-Higgs-doublet model of type II, the constrained minimal supersymmetric SM, etc.). In this case non-standard contributions are severely limited by the constraints from electroweak data. However, we stress that the high-precision obtained by LEP and SLC at the  $Z$  peak (typically at the per mille level), refers to observables that receive tree-level contributions within the SM. The accuracy on the pure quantum electroweak effects barely reaches the 10% level. Thus even within this constrained scenario one can expect deviations at the 10%–30% level in observables such as  $K \rightarrow \pi\nu\bar{\nu}$  rates. Detailed calculations performed within the flavour-constrained MSSM confirm this expectation.<sup>19</sup> In principle these effects could be detected, since they are above the intrinsic theoretical errors.

- *Models with new sources of quark-flavour mixing*, such as generic SUSY extensions of the SM, models with new generations of quarks, etc. On general grounds this category is the most natural one, since we expect some mechanism beyond the SM to be responsible for the observed flavour structure. Indeed the case of minimal flavour violation can be considered as a particular limit of this general category: the limit where the new sources of quark-flavour mixing appear only well above the electroweak scale. FCNCs could be dramatically affected by the presence of new sources of quark-flavour mixing, if the latter leads to overcoming the strong CKM hierarchy. This effect is potentially more pronounced in rare FCNC kaon decays, where the CKM structure implies an  $\mathcal{O}(\lambda^5)$  suppression of the leading amplitude, than in  $B$  de-

Table 1. Theoretical cleanliness of  $\Gamma(K_L \rightarrow \pi^0 \nu \bar{\nu})$ ,  $\Gamma(B \rightarrow X_s \gamma)$  and  $(g-2)_\mu$ :  $\delta_W$  denotes the pure electroweak contribution;  $\delta_{\text{QCD}}$  the impact of QCD corrections (both perturbative and non-perturbative ones);  $\Delta^{\text{th}}$  the overall theoretical uncertainty.

Observable	$\delta_{\text{QCD}}/\delta_W$	$\Delta^{\text{th}}/\delta_W$
$\Gamma(K_L \rightarrow \pi^0 \nu \bar{\nu})$	$< 10\%$	$< 3\%$
$\Gamma(B \rightarrow X_s \gamma)$	$\sim 300\%$	$(10-15)\%$
$(g-2)_\mu$	$\sim 4000\%$	$(50-100)\%$

cays. This naive expectation can explicitly be realized in specific and consistent frameworks.<sup>20-23</sup> In particular, within the non-constrained MSSM it is found<sup>22</sup> that  $\mathcal{B}(K_L \rightarrow \pi^0 \nu \bar{\nu})$  and/or  $\mathcal{B}_{\text{CPV-dir}}(K_L \rightarrow \pi^0 e^+ e^-)$  (to be defined later) could be enhanced over SM expectations up to one order of magnitude.

In general it is not easy to compare the sensitivity of different observables to physics beyond the SM, without making specific assumptions about it, and at present we have very limited clues about the nature of non-standard physics. In this situation, we believe that a useful guiding principle is provided by the theoretical cleanliness of a given process. In Table 1 we compare three well-known examples of observables that probe electroweak amplitudes at the quantum level:  $\Gamma(K_L \rightarrow \pi^0 \nu \bar{\nu})$ ,  $\Gamma(B \rightarrow X_s \gamma)$  (to be discussed later) and the anomalous magnetic moment of the muon.<sup>24</sup> As can be noted, the limited impact of QCD effects makes  $\Gamma(K_L \rightarrow \pi^0 \nu \bar{\nu})$  a privileged observatory. Of course this comparison is a bit provocative and should not be taken too seriously (the weak amplitudes probed by the three processes are clearly different), but it illustrates well the virtues of  $K_L \rightarrow \pi^0 \nu \bar{\nu}$ .

### 2.3 Experimental perspectives

The search for processes with missing energy and branching ratios below  $10^{-10}$  is defi-

nately a very difficult challenge, but has been proved not to be impossible.<sup>b</sup> A strong evidence of  $K^+ \rightarrow \pi^+ \nu \bar{\nu}$  has been obtained by the E787 experiments at BNL: a single event was observed in a signal region where the background expectation is below 10%.<sup>27</sup> The branching ratio inferred from this result,

$$\mathcal{B}(K^+ \rightarrow \pi^+ \nu \bar{\nu}) = (1.5_{-1.2}^{+3.4}) \times 10^{-10}, \quad (7)$$

is consistent with SM expectations, although the error does not allow precision tests of the model yet. E787 has completed its data taking in 1999 and should soon release a final analysis, including a new sample with statistics comparable to all its previous published results. In the meanwhile, a substantial upgrade of the experimental apparatus has been undertaken, resulting in a new experiment (BNL-E949) that should start taking data this year, with the goal of collecting about 10 events (at the SM rate) by 2003. In the longer term, a high-precision result on this mode will arise from the CKM experiment at Fermilab, which aims at a measurement of  $\mathcal{B}(K^+ \rightarrow \pi^+ \nu \bar{\nu})$  at the 10% level (see Fig. 4).

Unfortunately the progress concerning the neutral mode is much slower. No dedicated experiment has started yet (contrary to the  $K^+$  case) and the best direct limit is more than four orders of magnitude above the SM expectation.<sup>29</sup> An indirect model-independent upper bound on  $\Gamma(K_L \rightarrow \pi^0 \nu \bar{\nu})$  can be obtained by the isospin relation<sup>28</sup>

$$\Gamma(K^+ \rightarrow \pi^+ \nu \bar{\nu}) = \Gamma(K_L \rightarrow \pi^0 \nu \bar{\nu}) + \Gamma(K_S \rightarrow \pi^0 \nu \bar{\nu}) \quad (8)$$

which is valid for any  $s \rightarrow d \nu \bar{\nu}$  local operator of dimension  $\leq 8$  (up to small isospin-breaking corrections). Using the BNL-E787 result (7), this implies<sup>25</sup>

$$\mathcal{B}(K_L \rightarrow \pi^0 \nu \bar{\nu}) < 2.6 \times 10^{-9} \text{ (90\% CL)}. \quad (9)$$

<sup>b</sup> Extensive discussions about the experimental search for rare  $K$  decays can be found in the recent literature.<sup>18,25,26</sup>

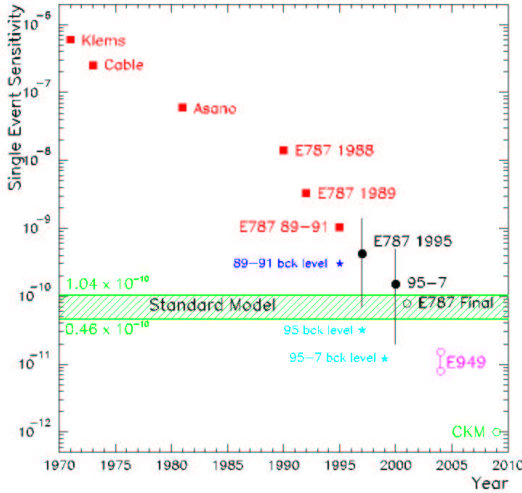

Figure 4. History and future prospects in the experimental search for  $K^+ \rightarrow \pi^+ \nu \bar{\nu}$ .<sup>26</sup>

Any experimental information below this figure can be translated into a non-trivial constraint on possible new-physics contributions to the  $s \rightarrow d \nu \bar{\nu}$  amplitude. The first experiment that should reach this goal is E931a at KEK,<sup>25</sup> at present under construction, which will also be the first  $K_L \rightarrow \pi^0 \nu \bar{\nu}$  dedicated experiment. The goal of KEK-E931 is to reach a single-event sensitivity (SES) of  $10^{-10}$ . The only approved experiment on  $K_L \rightarrow \pi^0 \nu \bar{\nu}$  is KOPIO at BNL,<sup>25</sup> whose goal is a SES of  $10^{-13}$ , or the observation of about 50 signal events (at the SM rate) with signal/background  $\approx 2$ . It is worthwhile to stress that KOPIO will be rather different from all existing kaon experiments at hadron colliders. Using a low-energy micro-bunched beam, KOPIO will be able to measure the  $K_L$  momentum by means of the time of flight. This measurement, together with the information on energy and directions of the two  $\pi^0$  photons, substantially enhance the discriminating power against the back-

ground (dominated by  $K_L \rightarrow 2\pi^0$  with missing photons). Unfortunately the construction of KOPIO has not started yet because of funding problems; if these can be solved soon, the experiment could start to run in 2006. Needless to say that, given the theoretical interest and the experimental difficulty, an independent experimental set-up dedicated to  $K_L \rightarrow \pi^0 \nu \bar{\nu}$  would be very welcome.<sup>18</sup>

### 3 $K \rightarrow \pi \ell^+ \ell^-$ and $K \rightarrow \ell^+ \ell^-$

Similarly to  $K \rightarrow \pi \nu \bar{\nu}$ , short-distance contributions to  $K \rightarrow \pi \ell^+ \ell^-$  and  $K \rightarrow \ell^+ \ell^-$  are calculable with high accuracy and are highly sensitive to modulus and phase of  $\lambda_t$ . However, in these processes the size of long-distance contributions is usually much larger because of electromagnetic interactions. Only in few cases (mainly in CP-violating observables) are long-distance contributions suppressed and it is then possible to extract the interesting short-distance information.

#### 3.1 $K \rightarrow \pi \ell^+ \ell^-$

Contrary to the  $s \rightarrow \nu \bar{\nu}$  case, the GIM mechanism of the  $s \rightarrow d \gamma^*$  amplitude is only logarithmic.<sup>30</sup> As a result, the  $K \rightarrow \pi \gamma^* \rightarrow \pi \ell^+ \ell^-$  amplitude is completely dominated by long-distance dynamics and provides a large contribution to the CP-allowed transitions  $K^+ \rightarrow \pi^+ \ell^+ \ell^-$  and  $K_S \rightarrow \pi^0 \ell^+ \ell^-$ .<sup>31</sup> This amplitude can be described in a model-independent way in terms of two form factors,  $W_+(z)$  and  $W_S(z)$ , defined by<sup>32</sup>

$$i \int d^4 x e^{iqx} \langle \pi | T \{ J_{\text{em}}^\mu(x) \mathcal{L}_{\Delta S=1}(0) \} | K_i \rangle = \frac{W_i(z)}{(4\pi)^2} [z(p_K + p_\pi)^\mu - (1 - r_\pi^2)q^\mu], \quad (10)$$

where  $q = p_K - p_\pi$ ,  $z = q^2/M_K^2$  and  $r_\pi = M_\pi/M_K$ . The two form factors are non singular at  $z = 0$  and, because of gauge invariance, vanish to lowest order in chiral perturbation theory (CHPT).<sup>31</sup> Beyond lowest or-

der two separate contributions to  $W_i(z)$  can be identified: a non-local term,  $W_i^{\pi\pi}(z)$ , due to the  $K \rightarrow 3\pi \rightarrow \pi\gamma^*$  scattering, and a local term,  $W_i^{\text{pol}}(z)$ , which encodes the contributions of unknown low-energy constants (to be determined by data). At  $\mathcal{O}(p^4)$  the local term is simply a constant, whereas at  $\mathcal{O}(p^6)$  also a linear slope in  $z$  arises. Note that already at  $\mathcal{O}(p^4)$  chiral symmetry alone does not help to relate  $W_S$  and  $W_+$ , or  $K_S$  and  $K^+$  decays.<sup>31</sup>

Recent results on  $K^+ \rightarrow \pi^+e^+e^-$  and  $K^+ \rightarrow \pi^+\mu^+\mu^-$  by BNL-E865<sup>33</sup> indicates very clearly that, owing to a large linear slope, the  $\mathcal{O}(p^4)$  expression of  $W_+(z)$  is not accurate enough. This should not be considered as a failure of CHPT, rather as an indication that large  $\mathcal{O}(p^6)$  contributions are present in this channel. Indeed the  $\mathcal{O}(p^6)$  expression of  $W_+(z)$  seems to fit the data well. Interestingly, this is not only due to a new free parameter appearing at  $\mathcal{O}(p^6)$ , but it is also due to the presence of the non-local term. The evidence of the latter provides a really significant test of the CHPT approach.

Knowing  $W_+(z)$ , we can make reliable predictions about the CP-violating asymmetry between  $K^+ \rightarrow \pi^+\ell^+\ell^-$  and  $K^- \rightarrow \pi^-\ell^+\ell^-$  distributions. This asymmetry is generated by the interference between the absorptive contribution of  $W_+(z)$  and the CP-violating phase of the  $s \rightarrow d\ell^+\ell^-$  amplitude, dominated by short-distance dynamics.<sup>31</sup> The integrated asymmetry for  $M_{\ell^+\ell^-} \geq 2M_\pi$  is around  $10^{-4}$ , within the SM, for both electron and muon modes.<sup>32</sup> A measurement at the 10% level, consistent with zero, has recently been reported by the HyperCP Collaboration at Fermilab.<sup>34</sup> In the near future significant improvements can be expected by the charged-kaon extension of the NA48 experiment at CERN,<sup>35</sup> although the sensitivity is likely to remain very far from SM expectations.

Similarly, also  $K_S \rightarrow \pi^0\ell^+\ell^-$  decays are dominated by long-distance dynamics; how-

ever, in this case non-local terms are very suppressed. To a good approximation, the  $K_S \rightarrow \pi^0e^+e^-$  rate can be written as

$$\mathcal{B}(K_S \rightarrow \pi^0e^+e^-) = 5 \times 10^{-9} \times a_S^2 \quad (11)$$

where  $a_S$ , defined by  $W_S^{\text{pol}}(0) = G_F m_K^2 a_S$ , is expected to be  $\mathcal{O}(1)$ . The recent bound<sup>36</sup>  $\mathcal{B}(K_S \rightarrow \pi^0e^+e^-) < 1.4 \times 10^{-7}$  is still one order of magnitude above the most optimistic expectations, but a measurement or a very stringent bound on  $|a_S|$  will soon arise from the  $K_S$ -dedicated run of NA48<sup>35</sup> and/or from KLOE at Frascati.<sup>37</sup>

Apart from its intrinsic interest, the determination of  $\mathcal{B}(K_S \rightarrow \pi^0e^+e^-)$  has important consequences on the  $K_L \rightarrow \pi^0e^+e^-$  mode. Here the long-distance part of the single-photon exchange amplitude is forbidden by CP invariance and the sensitivity to short-distance dynamics is enhanced. The direct-CP-violating part of the  $K_L \rightarrow \pi^0\ell^+\ell^-$  amplitude is conceptually similar to the one of  $K_L \rightarrow \pi^0\nu\bar{\nu}$ : it is calculable with high precision, being dominated by the top-quark contribution,<sup>38</sup> and is highly sensitive to non-standard dynamics.<sup>22</sup> This amplitude interfere with the indirect-CP-violating contribution induced by  $K_L$ - $K_S$  mixing, leading to<sup>32</sup>

$$\begin{aligned} \mathcal{B}(K_L \rightarrow \pi^0e^+e^-)_{\text{CPV}} &= 10^{-12} \\ &\times \left[ 15.3a_S^2 \pm 6.8 \frac{\Im\lambda_t}{10^{-4}} |a_S| + 2.8 \left( \frac{\Im\lambda_t}{10^{-4}} \right)^2 \right] \end{aligned} \quad (12)$$

where the  $\pm$  depends on the relative sign between short- and long-distance contributions, and cannot be determined in a model-independent way. Given the present uncertainty on  $\mathcal{B}(K_S \rightarrow \pi^0e^+e^-)$ , at the moment we can only set a rough upper limit of  $5.4 \times 10^{-10}$  on the sum of all the CP-violating contributions to this mode, to be compared with the direct limit of  $5.6 \times 10^{-10}$  obtained by KTeV at Fermilab.<sup>40</sup>

An additional contribution to  $K_L \rightarrow \pi^0\ell^+\ell^-$  decays is generated by the CP-

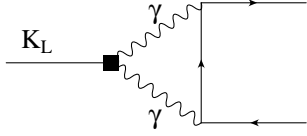

Figure 5. Two-photon contribution to  $K_L \rightarrow \ell^+ \ell^-$ .

conserving long-distance processes  $K_L \rightarrow \pi^0 \gamma \gamma \rightarrow \pi^0 \ell^+ \ell^-$ .<sup>39</sup> This amplitude does not interfere with the CP-violating one, and recent data<sup>35</sup> on  $K_L \rightarrow \pi^0 \gamma \gamma$  (at small dilepton invariant mass) by NA48 indicate that it is very suppressed, with an impact on  $\mathcal{B}(K_L \rightarrow \pi^0 e^+ e^-)$  at the level of  $\text{few} \times 10^{-12}$  at most. Moreover, if the  $K_L \rightarrow \pi^0 e^+ e^-$  were observed, the CP-conserving contribution could efficiently be isolated by a Dalitz plot analysis.

At the moment there exist no definite plans to improve the KTeV bound on  $\mathcal{B}(K_L \rightarrow \pi^0 e^+ e^-)$ . The future information on  $\mathcal{B}(K_S \rightarrow \pi^0 e^+ e^-)$  will play a crucial role in this respect: if  $a_S$  were in the range that maximizes the interference effect in (12), we believe it would be worth while to start a dedicated program to reach sensitivities of  $10^{-12}$ .

### 3.2 $K_L \rightarrow \ell^+ \ell^-$

Both  $K_L \rightarrow \mu^+ \mu^-$  and  $K_L \rightarrow e^+ e^-$  decays are dominated by the long-distance amplitude in Fig. 5. The absorptive part of the latter is determined to good accuracy by the two-photon discontinuity and is calculable with high precision in terms of the  $K_L \rightarrow \gamma \gamma$  rate. On the other hand, the dispersive contribution of the two-photon amplitude is a source of considerable theoretical uncertainties.

In the  $K_L \rightarrow e^+ e^-$  mode the dispersive integral is dominated by a large infrared logarithm [ $\sim \ln(m_K^2/m_e^2)$ ], the coupling of which can be determined in a model-independent way from  $\Gamma(K_L \rightarrow \gamma \gamma)$ . As a result,  $\Gamma(K_L \rightarrow$

$e^+ e^-$ ) can be estimated with good accuracy<sup>41</sup> but is almost insensitive to short-distance dynamics.

The  $K_L \rightarrow \mu^+ \mu^-$  mode is certainly more interesting from the short-distance point of view. Here the two-photon long-distance amplitude is not enhanced by large logs and is almost comparable in size with the short-distance one,<sup>8</sup> sensitive to  $\Re\lambda_t$ . Actually short- and long-distance dispersive parts cancel each other to a good extent, since the total  $K_L \rightarrow \mu^+ \mu^-$  rate (measured with high precision by BNL-E871<sup>42</sup>) is almost saturated by the absorptive two-photon contribution:<sup>43</sup>

$$\begin{aligned} \mathcal{B}(K_L \rightarrow \mu^+ \mu^-)^{\text{exp}} &= (7.15 \pm 0.16) \times 10^{-9} \\ \mathcal{B}(K_L \rightarrow \mu^+ \mu^-)_{2\gamma}^{\text{abs}} &= \frac{\alpha_{em}^2 m_\mu^2}{2m_K^2 \beta_\mu} \left[ \ln \frac{1 - \beta_\mu}{1 + \beta_\mu} \right]^2 \\ &\times \mathcal{B}(K_L \rightarrow \gamma \gamma) = (7.00 \pm 0.18) \times 10^{-9} \end{aligned}$$

$[\beta_\mu = (1 - 4m_\mu^2/m_K^2)^{1/2}]$ . The accuracy on which we can bound the two-photon dispersive integral determines the accuracy of possible bounds on  $\Re\lambda_t$ . A partial control of the  $K_L \rightarrow \gamma^* \gamma^*$  form factor, which rules the dispersive integral, can be obtained by means of  $K_L \rightarrow \gamma \ell^+ \ell^-$  and  $K_L \rightarrow e^+ e^- \mu^+ \mu^-$  spectra; additional constraints can also be obtained from model-dependent hadronic ansätze and/or perturbative QCD.<sup>44,45</sup> Combining this information, significant upper bounds on  $\Re\lambda_t$  (or lower bounds on  $\bar{\rho}$ ) have recently been obtained.<sup>42,46</sup> The reliability of these bounds has still to be fully investigated, but some progress can be expected in the near future. On the experimental side, a global and model-independent analysis could help to clarify the existing discrepancy<sup>46</sup> about the  $K_L \rightarrow \gamma^* \gamma$  form factor extracted from  $K_L \rightarrow \gamma e^+ e^-$  and  $K_L \rightarrow \gamma \mu^+ \mu^-$  modes; a better measurement of the  $K_L \rightarrow \gamma \gamma$  rate would also decrease the overall uncertainty of the absorptive contribution. On the theoretical side, the extrapolation of the form factor in the high-energy region, which so far requires model-dependent assumptions, could possibly be limited by means of lattice calcu-

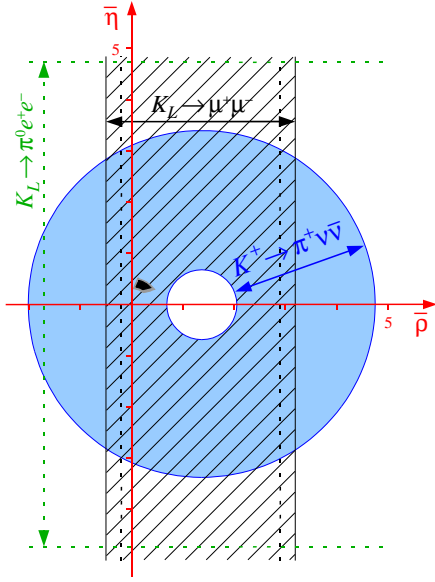

Figure 6. Present constraints in the  $\bar{p}$ - $\bar{\eta}$  plane from rare  $K$  decays (see text). The small dark region close to the origin denotes the constraints from  $B$ -physics and  $\epsilon_K$  (see Fig. 1).

lations.

### 3.3 Rare $K$ decays and the unitarity triangle

To conclude the discussion about rare  $K$  decays, we summarize in Fig. 6 the present impact of these modes in constraining the  $\bar{p}$ - $\bar{\eta}$  plane (complementing a recent plot by Littenberg<sup>26</sup>). The  $K^+ \rightarrow \pi^+ \nu \bar{\nu}$  constraints are those reported by BNL-E787.<sup>26,27</sup> The bound from  $K_{L,S} \rightarrow \pi^0 e^+ e^-$  has been obtained by means of Eq. (12), combining the recent experimental limits from KTeV<sup>40</sup> and NA48<sup>36</sup> on  $K_L$  and  $K_S$  decays, respectively. Finally, the  $K_L \rightarrow \mu^+ \mu^-$  constraint has been obtained by means of the  $K_L \rightarrow \gamma^* \gamma^*$  form factor by D’Ambrosio *et al.*,<sup>45</sup> combining theoretical and experimental errors linearly<sup>26</sup> (dashed region) or in a Gaussian way<sup>46</sup> (dashed vertical lines). These bounds are clearly less precise than those from  $B$ -physics; however, the comparison is already non-trivial, given the different nature of the

amplitudes involved. Interesting developments in the near future could arise by an increase of the lower bound on  $\mathcal{B}(K^+ \rightarrow \pi^+ \nu \bar{\nu})$ , possible if BNL-E787 has collected new signal events.

## 4 FCNCs in $B$ decays: generalities

Inclusive rare  $B$  decays such as  $B \rightarrow X_s \gamma$ ,  $B \rightarrow X_s \ell^+ \ell^-$  and  $B \rightarrow X_s \nu \bar{\nu}$  are the natural framework for high-precision studies of FCNCs in the  $\Delta B = 1$  sector.<sup>47</sup> Perturbative QCD and heavy-quark expansion<sup>48</sup> form a solid theoretical framework to describe these processes: inclusive hadronic rates are related to those of free  $b$  quarks, calculable in perturbation theory, by means of a systematic expansion in inverse powers of the  $b$ -quark mass.

The starting point of the perturbative partonic calculation is the determination of a low-energy effective Hamiltonian, renormalized at a scale  $\mu = \mathcal{O}(m_b)$ , obtained by integrating out the heavy degrees of freedom of the theory. For  $b \rightarrow s$  transitions –within the SM– this can be written as

$$\mathcal{H}_{\text{eff}} = -\frac{G_F}{\sqrt{2}} V_{ts}^* V_{tb} \sum_{i=1}^{10, \nu} C_i(\mu) Q_i + \text{h.c.} \quad (13)$$

where  $Q_{1..6}$  are four-quark operators,  $Q_8$  is the chromomagnetic operator,

$$Q_7 = \frac{e}{4\pi^2} \bar{s}_L \sigma_{\mu\nu} m_b b_R F^{\mu\nu} \quad (14)$$

$$Q_9 = \frac{e^2}{4\pi^2} \bar{s}_L \gamma^\mu b_L \bar{\ell} \gamma_\mu \ell \quad (15)$$

$$Q_{10} = \frac{e^2}{4\pi^2} \bar{s}_L \gamma^\mu b_L \bar{\ell} \gamma_\mu \gamma_5 \ell \quad (16)$$

and  $Q_\nu$  is the  $b \rightarrow s$  analogue of  $Q_L^\nu$  in Eq. (3). Within the SM, the coefficients of all the FCNC operators ( $Q_7$ ,  $Q_9$ ,  $Q_{10}$  and  $Q_\nu$ ) receive a large non-decoupling contribution from top-quark loops at the electroweak scale. Nonetheless, the  $m_t$  dependence is not the same for all the operators, reflecting a different  $SU(2)_L$ -breaking structure, which can

be affected in a rather different way by new-physics contributions.<sup>49</sup>

The calculation of partonic rates then involves three distinct steps: i) the determination of the initial conditions of the Wilson coefficients at the electroweak scale; ii) the evolution by means of renormalization-group equations (RGEs) of the  $C_i$  down to  $\mu = \mathcal{O}(m_b)$ ; iii) the evaluation of the QCD corrections to the matrix elements of the effective operators at  $\mu = \mathcal{O}(m_b)$ . The interesting short-distance dynamics that we would like to test enters only in the first step; however, the following two steps are fundamental ingredients to reduce and control the theoretical error. The status of these steps for the three main channels can be summarized as follows:

$b \rightarrow s\gamma$  As anticipated, QCD corrections play an important role in  $b \rightarrow s\gamma$ : the large logarithms generated by the mixing of four-quark operators with  $Q_7$  (see Fig. 7) enhance the partonic rate by a factor of almost three.<sup>50</sup> Since the mixing of  $Q_7$  with  $Q_{1\dots 6}$  vanishes at the one-loop level, in this case a full treatment of QCD corrections beyond leading logarithms is a rather non-trivial task. This has been achieved thanks to the joint effort of many authors.<sup>47</sup> In particular, the original calculations of SM initial conditions<sup>51</sup> and matrix element corrections<sup>52</sup> have already been confirmed by different groups;<sup>53,54</sup> the only part of the SM result performed by a single collaboration is the three-loop mixing of  $Q_7$  and  $Q_{1\dots 6}$  (notably the most difficult step of the whole calculation).<sup>55</sup> The accuracy of the perturbative SM result has also been improved with the inclusion of subleading electroweak corrections.<sup>56</sup> Finally, the initial conditions of Wilson coefficients have been determined beyond lowest order also in the two-Higgs doublet model of type II<sup>57</sup> and in the constrained

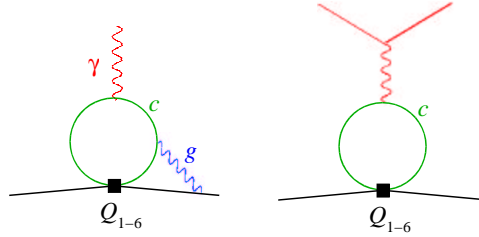

Figure 7. Representative diagrams for the mixing of four-quark operators into  $Q_7$  (left) and  $Q_9$  (right).

MSSM.<sup>58,59</sup>

$b \rightarrow sl^+\ell^-$  Since  $Q_9$  mixes with four-quark operators already at the one-loop level (see Fig. 7), in this case QCD corrections are even more important than for  $b \rightarrow s\gamma$ . This fact facilitates the NLO calculation,<sup>60</sup> but enhances the relative importance of NNLO corrections. The latter have recently become available for the initial conditions and (part of) the matrix elements.<sup>61</sup>

Interestingly, the impact of QCD corrections is very limited in the axial-current operator  $Q_{10}$ , which also contributes to  $b \rightarrow sl^+\ell^-$ . This operator does not mix with four-quark operators and is completely dominated by short-distance contributions. Together with  $Q_\nu$ ,  $Q_{10}$  belongs to the theoretically clean  $\mathcal{O}(G_F^2)$  hard-GIM-protected part of the effective Hamiltonian (13). Thus observables more sensitive to  $Q_{10}$ , such as the forward-backward lepton asymmetry, have a reduced QCD uncertainty and a strong sensitivity to possible non-standard phenomena.

$b \rightarrow s\nu\bar{\nu}$  QCD corrections to the  $b \rightarrow s\nu\bar{\nu}$  amplitude are the same as needed for the  $s \rightarrow d\nu\bar{\nu}$  one,<sup>8,9,10</sup> with the advantage that charm- and light-quark contributions are not CKM-enhanced and thus are completely negligible also in the real (CP-conserving) part. In other words,

the only non-trivial step of the perturbative calculation for  $b \rightarrow s\nu\bar{\nu}$  decays is the determination of the initial condition of  $C_\nu$ , which is known with a precision around 1% within the SM.

The experimental upper limit

$$\mathcal{B}(B \rightarrow X_s\nu\bar{\nu}) < 6.4 \times 10^{-4} \quad (17)$$

has been announced this year by the ALEPH collaboration at LEP.<sup>62</sup> This has to be compared with a SM prediction<sup>47</sup> of about  $3.5 \times 10^{-5}$ . Similarly to  $K \rightarrow \pi\nu\bar{\nu}$  decays, the  $b \rightarrow s\nu\bar{\nu}$  transition can probe many new-physics scenarios<sup>63</sup> and deserve the maximum of attention. Hopefully, the gap between SM expectations and experimental limits could decrease in the next few years at  $B$ -factory experiments.

The three steps of the perturbative calculation can easily be transferred from the  $b \rightarrow s$  case to the  $b \rightarrow d$  one,<sup>64</sup> although the structure of the effective Hamiltonian is richer in the latter, owing to the presence of two comparable CKM factors ( $V_{td}^*V_{tb}$  and  $V_{us}^*V_{ub}$ ). Being insensitive to  $V_{td}$ ,  $b \rightarrow s$  transitions are not interesting for precision tests in the  $\bar{\rho}-\bar{\eta}$  plane; these processes are particularly useful to constrain (or even to detect) possible extensions of the SM. On the contrary,  $b \rightarrow d$  transitions are very sensitive to  $\bar{\rho}$  and  $\bar{\eta}$ , but are clearly disfavoured from the experimental point of view because of the additional  $\mathcal{O}(\lambda^2)$  suppression.

## 5 $B \rightarrow X_{s,d}\gamma$

The inclusive  $B \rightarrow X_s\gamma$  rate is the most significant information that we have at present on  $\Delta B = 1$  FCNCs. New precise measurements have recently been reported by CLEO at Cornell<sup>65</sup> and by BELLE at KEK.<sup>66</sup> Combining them with previous determinations,<sup>43</sup> the world average reads

$$\mathcal{B}(B \rightarrow X_s\gamma)^{\text{exp}} = (3.23 \pm 0.42) \times 10^{-4} \quad (18)$$

On the theory side, non-perturbative  $1/m_b$  corrections are well under control in the total rate. In particular,  $\mathcal{O}(1/m_b)$  corrections vanish in the ratio  $\Gamma(B \rightarrow X_s\gamma)/\Gamma(B \rightarrow X_c\ell\nu)$ , and the  $\mathcal{O}(1/m_b^2)$  ones are known and amount to few per cent.<sup>67</sup> Also non-perturbative effects associated to charm-quark loops have been estimated and found to be very small.<sup>68,69,70</sup> The most serious problem of non-perturbative origin is related to the (unavoidable) experimental cut in the photon energy spectrum that prevents the measurement from being fully inclusive.<sup>69,71</sup> With the present cut by CLEO,<sup>65</sup>  $E_\gamma > 2.0$  GeV, this uncertainty is smaller but non-negligible with respect to the error of the perturbative calculation. The latter is around 10% and its main source is the uncertainty in the ratio  $m_c/m_b$  that enters through charm-quark loops.<sup>72</sup> According to a recent analysis of all the theoretical uncertainties,<sup>72</sup> the SM expectation is given by

$$\mathcal{B}(B \rightarrow X_s\gamma)_{\text{SM}} = (3.73 \pm 0.30) \times 10^{-4}, \quad (19)$$

in good agreement with Eq. (18). Some comments are in order:

- The central value of the SM prediction in Eq. (19) is considerably higher than in all previous analyses since  $\bar{m}_c(\mu)$  has been used, rather than the charm pole mass, in the ratio  $m_c/m_b^{\text{pole}}$  appearing in charm-quark loops. This choice is believed to minimize NNLO corrections.<sup>72</sup>
- The overall scale dependence is very small: for  $\mu \in [m_b/2, 2m_b]$  the central value moves by about 1%. Therefore the error in Eq. (19) is an educated guess, whose dominant source is the variation of  $\bar{m}_c(\mu)/m_b^{\text{pole}}$  for  $\mu \in [m_c, m_b]$  [note that the scale-independent ratio  $\bar{m}_c(\mu)/\bar{m}_b(\mu)$  is well within this interval]. Additional uncertainties have been combined in quadrature; it is thus more appropriate to consider the r.h.s. of Eq. (19) as central value and standard

deviation of a Gaussian distribution, rather than as a flat interval.

- Eq. (19) does not include the error induced by the extrapolation below the  $E_\gamma$  cut. This theoretical uncertainty is included in the experimental result and, for  $E_\gamma^{\min} = 2.0$  GeV, is around 50% of the error in (19). It is worth while to stress that precise data on the photon spectrum (above the cut) could help to have a better control on this source of uncertainty.<sup>71</sup>

The comparison between theory and experiments in  $\mathcal{B}(B \rightarrow X_s \gamma)$  is a great success of the SM and has led us to derive many significant bounds on possible new-physics scenarios. Non-standard effects of  $\mathcal{O}(1)$  are definitely excluded, resulting in stringent constraints of models with generic flavour structures, like the unconstrained MSSM.<sup>73</sup> Deviations at the 10%–30% level, as generally expected within models with minimal flavour violation,<sup>58,72,74</sup> are still possible, and improved measurements of  $\mathcal{B}(B \rightarrow X_s \gamma)$  are certainly useful to further constrain this possibility. On the other hand, since the experimental error has reached the level of the theoretical one, it will be very difficult to clearly identify possible deviations from the SM, if any, in this observable.

Hopes to detect new-physics signals are still open through the CP-violating asymmetry

$$A_{\text{CP}}^s = \frac{\Gamma(B \rightarrow X_s \gamma) - \Gamma(\bar{B} \rightarrow X_s \gamma)}{\Gamma(B \rightarrow X_s \gamma) + \Gamma(\bar{B} \rightarrow X_s \gamma)}. \quad (20)$$

This is expected to be below 1% within the SM,<sup>64,75</sup> but could easily reach  $\mathcal{O}(10\%)$  values beyond the SM, even in the absence of large effects in the total  $B \rightarrow X_s \gamma$  rate. The present measurement of  $A_{\text{CP}}^s$  is consistent with zero,<sup>76</sup> but the sensitivity is still one order of magnitude above the SM level.

The experimental search for the  $B_d \rightarrow X_d \gamma$  transition is clearly a very hard task.

In particular, the background generated by  $B_d \rightarrow X_s \gamma$ , which has a rate 10–20 times larger,<sup>64</sup> appears to be a serious obstacle for the inclusive measurement, at least in the short term. More promising from the experimental point of view are exclusive  $b \rightarrow d$  transitions, such as  $B \rightarrow \rho \gamma$ , which have been the subject of recent systematic analyses beyond the naive factorization approach.<sup>77–80</sup> At present the overall theoretical error on  $\mathcal{B}(B \rightarrow \rho \gamma)$  is around 30% and is dominated by the uncertainty on the hadronic form factors.<sup>80</sup> Lattice calculations and new experimental data could possibly help to reduce this error in the near future.

Similarly to the  $b \rightarrow s$  case, also in  $b \rightarrow d$  transitions CP asymmetries are a powerful tool to search for new physics. An observable particularly appealing both from the experimental and the theoretical point of view is the following inclusive asymmetry

$$\mathcal{B}(B \rightarrow X_s \gamma) + \mathcal{B}(B \rightarrow X_d \gamma) - [B \rightarrow \bar{B}]. \quad (21)$$

Because of the unitarity of the CKM matrix, the asymmetry (21) is expected to be vanishingly small within the SM [of  $\mathcal{O}(10^{-9})$ ]<sup>81</sup> and thus is an excellent probe of non-standard scenarios.

## 6 Inclusive and exclusive $b \rightarrow s \ell^+ \ell^-$ transitions

The experimental search for FCNC decays of the  $B$  meson into a charged-lepton pair is just entering into an exciting era: the first evidence of this type of transition has been announced by BELLE at this conference<sup>82</sup>

$$\mathcal{B}(B \rightarrow K \ell^+ \ell^-) = (0.75_{-0.21}^{+0.25} \pm 0.09) \times 10^{-6} \quad (22)$$

and upper bounds very close to SM expectations have been reported both by BABAR<sup>83</sup> and BELLE<sup>82</sup> for all the three-body decays of the type  $B \rightarrow (K, K^*) + (\mu^+ \mu^-, e^+ e^-)$ .

Similarly to the  $b \rightarrow s \gamma$  case, the cleanest theoretical predictions are obtained

for sufficiently inclusive observables. Non-perturbative  $1/m_b$  corrections are well under control in the total rate and in the differential dilepton spectrum  $d(\Gamma \rightarrow X_s \ell^+ \ell^-)/ds$  (but for the end-point  $s = M_{\ell^+ \ell^-}^2/m_b^2 \approx 1$ ).<sup>84,85</sup> Non-perturbative effects associated to charm-quark loops are very large for  $M_{\ell^+ \ell^-}$  in the region of the narrow  $c\bar{c}$  resonances (see Fig. 8), but they are under control sufficiently far from this region.<sup>70,86</sup> As a result of these two effects, the cleanest predictions can be performed for  $M_{\ell^+ \ell^-}^2 \lesssim 6 \text{ GeV}^2$ .

An important feature of  $b \rightarrow s \ell^+ \ell^-$  transitions is their sensitivity to the Wilson coefficients  $C_{9,10}$ . The latter could be strongly modified in several new-physics scenarios, without observable consequences on  $b \rightarrow s \gamma$ .<sup>87–90</sup> As long as the basis of effective operators is the SM one, the purely perturbative dilepton spectrum can be written as<sup>60</sup>

$$\begin{aligned} \frac{d}{ds} \Gamma(B \rightarrow X_s e^+ e^-) &\propto (1-s)^2 \\ &\times \left\{ 4 \frac{s+2}{s} |C_7|^2 + 12 \Re [C_7^* C_9^{\text{eff}}(s)] \right. \\ &\left. + (1+2s) (|C_9^{\text{eff}}(s)|^2 + |C_{10}|^2) \right\}, \end{aligned} \quad (23)$$

where  $C_9^{\text{eff}}(s)$  is an appropriate combination of  $C_9$  and the Wilson coefficients of four-quark operators.<sup>60</sup> At very small  $s$ , the dominant contribution is that of  $C_7$ , enhanced by  $1/s$ ; however, for  $s \approx 0.1$  a rapid change of slope is expected because of the interference between  $C_7$  and  $C_9$  (see Fig. 8). Since this effect occurs in the theoretically clean part of the spectrum, it could be used to perform new high-precision tests of the SM. Even more interesting short-distance tests could be performed by means of the forward–backward asymmetry of the dilepton distribution.<sup>87</sup>

The high-precision studies allowed by inclusive modes will certainly have to wait a few years because of experimental difficulties. On the other hand, three-body exclusive modes are certainly within the reach of  $B$ -factories. The recent bounds<sup>89,90</sup> on  $B \rightarrow$

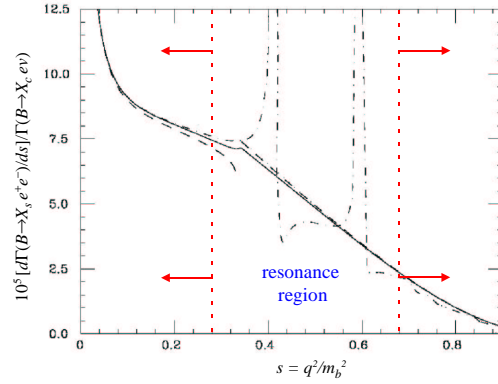

Figure 8. Dilepton spectrum of the inclusive  $B \rightarrow X_s e^+ e^-$  decay within the SM. The full line denote the pure perturbative result (at fixed renormalization scale), dashed and dash-dotted lines correspond to estimates of non-perturbative  $c\bar{c}$  effects.<sup>70,86</sup>

$(K, K^*) + (\mu^+ \mu^-, e^+ e^-)$  already led us to exclude some of the most exotic new-physics scenarios:<sup>88,89,90</sup> non-standard contributions to  $C_{9,10}$  can be at most of the same order as that of the SM. Given this situation, it is difficult to detect possible deviations from the SM in the total exclusive rates, where the theoretical uncertainties are around 30% (or above). A much more interesting observable in this respect is provided by the lepton forward–backward (FB) asymmetry. In the  $B \rightarrow K^* \mu^+ \mu^-$  case this is defined as

$$A_{FB}(s) = \frac{1}{d\Gamma(B \rightarrow K^* \mu^+ \mu^-)/ds} \int_{-1}^1 d \cos \theta \frac{d^2 \Gamma(B \rightarrow K^* \mu^+ \mu^-)}{ds d \cos \theta} \text{sgn}(\cos \theta), \quad (24)$$

where  $\theta$  is the angle between  $\mu^+$  and  $B$  momenta in the dilepton centre-of-mass frame. Assuming that the leptonic current has only a vector ( $V$ ) or axial-vector ( $A$ ) structure, then the FB asymmetry provides a direct measure of the  $A$ – $V$  interference. Indeed, at LO and employing the SM operator basis, one can write

$$A_{FB}(s) \propto \text{Re} \left\{ C_{10}^* \left[ s C_9^{\text{eff}} + r(s) \frac{m_b C_7}{m_B} \right] \right\}$$

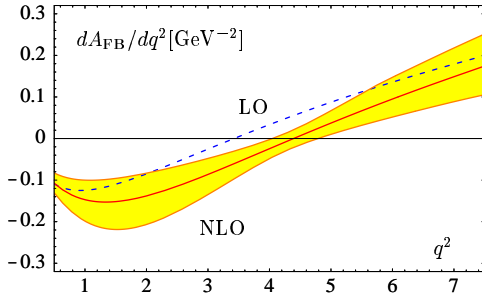

Figure 9. Forward-backward asymmetry of  $B^- \rightarrow K^{*-} \ell^+ \ell^-$  at LO and NLO. The band reflects all theoretical uncertainties from parameters and scale dependence combined.<sup>79</sup>

where  $r(s)$  is an appropriate ratio of hadronic form factors.<sup>91</sup> The overall factor ruling the magnitude of  $A_{FB}(s)$  is affected by sizeable theoretical uncertainties. Nonetheless, there are three features of this observable that provide a clear and independent short-distance information:

- i. Within the SM  $A_{FB}(s)$  has a zero in the low- $s$  region (see Fig. 9).<sup>91</sup> The position of this zero, which depends on the relative magnitude and sign of  $C_7$  and  $C_9$ , can be determined to a good accuracy within the SM. As recently shown by means of a full NLO calculation,<sup>79</sup> the experimental measurement of  $s_0$  could allow a determination of  $C_7/C_9$  at the 10% level.
- ii. The sign of  $A_{FB}(s)$  around the zero is fixed unambiguously in terms of the relative sign of  $C_{10}$  and  $C_9$ :<sup>90</sup> within the SM one expects  $A_{FB}(s) > 0$  for  $s > s_0$ , for  $\bar{B}$  mesons, as shown in Fig. 9.
- iii. In the limit of CP conservation one expects  $A_{FB}^{(\bar{B})}(s) = -A_{FB}^{(B)}(s)$ . This holds at the per-mille level within the SM,<sup>90</sup> where  $C_{10}$  has a negligible CP-violating phase, but it could be substantially different in the presence of new physics.

### 6.1 $B_{s,d} \rightarrow \ell^+ \ell^-$

The purely leptonic decays constitute a special case among exclusive transitions. Within the SM only the axial-current operator,  $Q_{10}$ , induces a non-vanishing contribution to these processes. As a result, the short-distance contribution is not *diluted* by the mixing with four-quark operators. Moreover, the hadronic matrix element involved is the simplest we can consider, namely the  $B$ -meson decay constant

$$\langle 0 | \bar{q} \gamma_\mu \gamma_5 b | \bar{B}_q(p) \rangle = i p_\mu f_{B_q} \quad (25)$$

Reliable estimates of  $f_{B_d}$  and  $f_{B_s}$  are obtained at present from lattice calculations and in the future it will be possible to cross-check these results by means of the  $B^+ \rightarrow \ell^+ \nu$  rate. Modulo the determination of  $f_{B_q}$ , the theoretical cleanliness of  $B_{s,d} \rightarrow \ell^+ \ell^-$  decays is comparable to that of  $K_L \rightarrow \pi^0 \nu \bar{\nu}$  and  $B \rightarrow X_{s,d} \nu \bar{\nu}$ .

Compared to their kaon counterparts ( $K_L \rightarrow \mu^+ \mu^-$  and  $K_L \rightarrow e^+ e^-$ )  $B_{s,d} \rightarrow \ell^+ \ell^-$  decays have the big advantage that the two-photon amplitude is completely negligible.<sup>c</sup> However, the price to pay is a strong helicity suppression for  $\ell = \mu$  (and  $\ell = e$ ), or the channels with the best experimental signature. Employing the full NLO expression<sup>9,10</sup> of  $C_{10}$ , we can write

$$\begin{aligned} \mathcal{B}(B_s \rightarrow \mu^+ \mu^-)_{\text{SM}} &= 3.1 \times 10^{-9} \left( \frac{|V_{ts}|}{0.04} \right)^2 \\ &\times \left( \frac{f_{B_s}}{0.21 \text{ GeV}} \right)^2 \left( \frac{\tau_{B_s}}{1.6 \text{ ps}} \right) \left( \frac{m_t(m_t)}{166 \text{ GeV}} \right)^{3.12} \\ \frac{\mathcal{B}(B_s \rightarrow \tau^+ \tau^-)_{\text{SM}}}{\mathcal{B}(B_s \rightarrow \mu^+ \mu^-)_{\text{SM}}} &= 215 . \end{aligned}$$

The corresponding  $B_d$  modes are both suppressed by an additional factor  $|V_{td}/V_{ts}|^2$

<sup>c</sup> The smallness of the two-photon contribution with respect to the short-distance one in  $B_{s,d} \rightarrow \ell^+ \ell^-$  decays can easily be deduced from a comparison with the  $K_L \rightarrow \ell^+ \ell^-$  case, once short- and long-distance contributions are rescaled by the appropriate kinematical and CKM factors.

$= (4.0 \pm 0.8) \times 10^{-2}$ . The present experimental bound closest to SM expectations is the one obtained by CDF, at Fermilab, on  $B_s \rightarrow \mu^+ \mu^-$ :

$$\mathcal{B}(B_s \rightarrow \mu^+ \mu^-) < 2.6 \times 10^{-6} \quad (95\% \text{ CL}),$$

which is still very far from the SM level. The latter will certainly not be reached before the LHC era.

As emphasized in the recent literature,<sup>93–95</sup> the purely leptonic decays of  $B_s$  and  $B_d$  mesons are excellent probes of a specific type of new-physics amplitudes, namely enhanced scalar (and pseudoscalar) FCNCs. Scalar FCNC operators, such as  $\bar{b}_R s_L \bar{\mu}_R \mu_L$ , are present within the SM but are absolutely negligible because of the smallness of down-type Yukawa couplings. On the other hand, these amplitudes could be non-negligible in models with an extended Higgs sector. In particular, within the MSSM, where two Higgs doublets are coupled separately to up- and down-type quarks, a strong enhancement of scalar FCNCs can occur at large  $\tan \beta = v_u/v_d$ .<sup>93</sup> This effect would be practically undetectable in non-helicity-suppressed  $B$  decays and in  $K$  decays (because of the small Yukawa couplings), but could enhance  $B \rightarrow \ell^+ \ell^-$  rates by orders of magnitude, up to the present experimental bounds.<sup>94,95</sup> The search for these processes is therefore very interesting, even if we are still very far from the SM level. Experiments at hadron colliders, such as CDF or, in a long-term perspective, LHCb, are certainly advantaged in the search of  $B_{s,d} \rightarrow \mu^+ \mu^-$ .  $B$ -factory experiments could try to complement the picture searching for  $B_d \rightarrow \tau^+ \tau^-$ .<sup>95</sup>

## 7 Other rare processes

### 7.1 FCNCs in $D$ decays

The phenomenology of FCNCs with external up-type quarks, such as charm, is completely different from the examples discussed

so far.<sup>96</sup> In  $K$  and  $B$  decays the short-distance dominance of the clean SM transitions is ensured by the presence of the heavy top, which induces non-decoupling contributions growing with  $m_t$  [as explicitly shown in (2)]. A similar phenomenon cannot occur in  $c \rightarrow u$  transitions, because of the simultaneous smallness of  $m_b$  and of the CKM factor  $V_{cb} V_{ub}^*$ . Even for  $c \rightarrow u$  amplitudes with a hard GIM mechanism, the long-distance contribution dominates within the SM. As a result, FCNC  $D$  decays cannot be used to make precision tests of the CKM mechanism.

In cases where it is possible to put a firm upper bound on the long-distance contribution, FCNC  $D$  decays can be used to probe new-physics scenarios. This possibility has recently been discussed for  $D \rightarrow P \ell^+ \ell^-$ ,  $D \rightarrow V \gamma$  and  $D \rightarrow \gamma \gamma$  modes,<sup>97</sup> where there is still a considerable gap between SM expectations and experimental limits. Note that only exotic non-standard scenarios can be probed by means of FCNC  $D$  decays. Indeed, to be clearly identified, the new-physics source should produce order-of-magnitude enhancements over a long-distance SM amplitude.

### 7.2 Lepton-flavour-violating modes

Decays like  $K_L \rightarrow \mu e$ ,  $K \rightarrow \pi \mu e$  (as well as similar  $D$  and  $B$  modes) are completely forbidden within the SM, where lepton flavour is conserved, but are also absolutely negligible if we simply extend the model by including only Dirac-type neutrino masses. A positive evidence of any of these processes would therefore unambiguously signal new physics, calling for non-minimal extensions of the SM.

In exotic scenarios, such as  $R$ -parity-violating SUSY or models with leptoquarks, the  $q_i \rightarrow q_j \mu e$  amplitude can already be generated at tree level. In this case, even for high new-physics scales it is possible to generate lepton-flavour transitions close to the present experimental limits. In particular,

the bound<sup>98</sup>

$$\mathcal{B}(K_L \rightarrow \mu e) < 4.7 \times 10^{-12}, \quad (26)$$

which is the most stringent limit on these types of transitions, let us put a bound on leptoquark masses above 100 TeV (assuming electroweak couplings).

In more conservative scenarios, such as the generic MSSM, where  $q_i \rightarrow q_j \mu e$  transitions occur only at the one-loop level and the mechanisms for quark- and lepton-flavour mixing are separate, the rates for lepton-flavour-violating  $K$ ,  $D$  and  $B$  decays are naturally well below the level of current experimental bounds. Nonetheless, as recently shown,<sup>99</sup> the branching ratio for  $K_L \rightarrow \mu e$  in the MSSM with generic flavour couplings and  $R$ -parity conservation could be as large as  $10^{-15}$ , a level that could be accessible to a new generation of rare- $K$ -decay experiments.<sup>18</sup>

## 8 Conclusions

Rare FCNC decays of  $K$  and  $B$  mesons provide a unique opportunity to perform high-precision tests of CP violation and flavour mixing, both within and beyond the SM.

The  $B \rightarrow X_s \gamma$  rate represents the highest peak in our present knowledge of FCNCs: both experimental and theoretical errors have reached a comparable level of precision, around 10%, and the agreement between theory and data constitutes a highly non-trivial constraint for many extensions of the SM.

The lack of deviations from SM expectations in  $\Gamma(B \rightarrow X_s \gamma)$  should not discourage the search for other rare FCNC observables. As emphasized several times during this talk, there are still several observables, such as the forward-backward asymmetry in  $B \rightarrow K^* \ell^+ \ell^-$  or the rates of  $B \rightarrow \ell^+ \ell^-$  and  $K \rightarrow \pi \nu \bar{\nu}$  modes, where sizeable deviations from the SM are possible and are expected in specific new-physics models.

The measurement of observables with theoretical errors at the per-cent level, such as  $\Gamma(K_L \rightarrow \pi^0 \nu \bar{\nu})$ ,  $\Gamma(B \rightarrow X_s \nu \bar{\nu})$  and  $\Gamma(B_{s,d} \rightarrow \mu^+ \mu^-)$ , is a very important long-term perspective. Even if new physics will first be discovered elsewhere, e.g. at future hadron colliders, the experimental study of such processes would still be very useful to investigate the flavour structure of any new-physics scenario.

## Acknowledgements

I am grateful to Juliet and Paolo Franzini for the invitation to this interesting and very well organized conference. Many thanks are also due to Gerhard Buchalla, Andrzej Buras, Giancarlo D'Ambrosio, Paolo Gambino, Tobias Hurth and Guido Martinelli for several discussions on the subject of rare decays and/or comments on the manuscript. This work is partially supported by the EU-TMR Network EURODPAPHNE, ERBFMRXCT-980169.

## References

1. S. L. Glashow, J. Iliopoulos and L. Maiani, *Phys. Rev. D* **2**, 1285 (1970).
2. L. Wolfenstein, *Phys. Rev. Lett.* **51**, 1945 (1983).
3. N. Cabibbo, *Phys. Rev. Lett.* **10**, 531 (1963); M. Kobayashi and T. Maskawa, *Prog. Theor. Phys.* **49**, 652 (1973).
4. B. Aubert *et al.* [BABAR Collab.], *Phys. Rev. Lett.* **87**, 091801 (2001) [arXiv:hep-ex/0107013].
5. K. Abe *et al.* [BELLE Collab.], *Phys. Rev. Lett.* **87**, 091802 (2001) [arXiv:hep-ex/0107061].
6. M. Neubert, these proceedings; see also A. J. Buras, arXiv:hep-ph/0109197.
7. A. J. Buras, M. E. Lautenbacher and G. Ostermaier, *Phys. Rev. D* **50**, 3433 (1994) [arXiv:hep-ph/9403384].
8. G. Buchalla and A. J. Buras, *Nucl.*

- Phys. B* **398**, 285 (1993); **400**, 225 (1993); **412**, 106 (1994) [arXiv:hep-ph/9308272].
9. M. Misiak and J. Urban, *Phys. Lett. B* **451**, 161 (1999) [arXiv:hep-ph/9901278].
  10. G. Buchalla and A. J. Buras, *Nucl. Phys. B* **548**, 309 (1999) [arXiv:hep-ph/9901288].
  11. G. Buchalla and A. J. Buras, *Phys. Rev. D* **57**, 216 (1998) [arXiv:hep-ph/9707243].
  12. A. F. Falk, A. Lewandowski and A. A. Petrov, *Phys. Lett. B* **505**, 107 (2001) [arXiv:hep-ph/0012099].
  13. M. Lu and M. Wise, *Phys. Lett. B* **324**, 461 (1994) [arXiv:hep-ph/9401204].
  14. L. Littenberg, *Phys. Rev. D* **39**, 3322 (1989).
  15. G. Buchalla and A. J. Buras, *Phys. Rev. D* **54**, 6782 (1996) [arXiv:hep-ph/9607447].
  16. G. Buchalla and G. Isidori, *Phys. Lett. B* **440**, 170 (1998) [arXiv:hep-ph/9806501]; D. Rein and L.M. Sehgal, *Phys. Rev. D* **39**, 3325 (1989).
  17. W.J. Marciano and Z. Parsa, *Phys. Rev. D* **53**, R1 (1996).
  18. A. Belyaev *et al.* [ECFA-CERN Kaon Physics Working Group], arXiv:hep-ph/0107046.
  19. A. J. Buras *et al.*, *Nucl. Phys. B* **592**, 55 (2001) [arXiv:hep-ph/0007313].
  20. Y. Nir and M. P. Worah, *Phys. Lett. B* **423**, 319 (1998) [arXiv:hep-ph/9711215]; A. J. Buras, A. Romanino and L. Silvestrini, *Nucl. Phys. B* **520**, 3 (1998) [arXiv:hep-ph/9712398]; G. Colangelo and G. Isidori, *JHEP* **09**, 009 (1998) [arXiv:hep-ph/9808487].
  21. A. Masiero and O. Vives, *Phys. Rev. Lett.* **86**, 26 (2001) [arXiv:hep-ph/0007320].
  22. A. J. Buras *et al.*, *Nucl. Phys. B* **566**, 3 (2000) [arXiv:hep-ph/9908371].
  23. P. Q. Hung and A. Soddu, arXiv:hep-ph/0108119.
  24. J. Miller, these proceedings.
  25. A. R. Barker and S. H. Kettell, *Annu. Rev. Nucl. Part. Sci.* **50**, 249 (2000) [arXiv:hep-ex/0009024].
  26. L. Littenberg, arXiv:hep-ex/0010048.
  27. S. Adler *et al.* [E787 Collab.], *Phys. Rev. Lett.* **84**, 3768 (2000) [arXiv:hep-ex/0002015]; **79**, 2204 (1997) [arXiv:hep-ex/9708031];
  28. Y. Grossman and Y. Nir, *Phys. Lett. B* **398**, 163 (1997) [arXiv:hep-ph/9701313].
  29. J. Adams *et al.* [KTeV Collab.], *Phys. Lett. B* **447**, 240 (1999) [arXiv:hep-ex/9806007].
  30. F. J. Gilman and M. B. Wise, *Phys. Rev. D* **21**, 3150 (1980).
  31. G. Ecker, A. Pich and E. de Rafael, *Nucl. Phys. B* **291**, 692 (1987).
  32. G. D'Ambrosio, G. Ecker, G. Isidori and J. Portolés, *JHEP* **08**, 004 (1998).
  33. R. Appel *et al.* [E865 Collab.], *Phys. Rev. Lett.* **83**, 4482 (1999) [arXiv:hep-ex/9907045]. H. Ma *et al.* [E865 Collab.], *Phys. Rev. Lett.* **84**, 2580 (2000) [arXiv:hep-ex/9910047].
  34. H. K. Park *et al.* [HyperCP Collab.] arXiv:hep-ex/0110033
  35. L. Iconomidou-Fayard, these proceedings; <http://www1.cern.ch/NA48>
  36. A. Lai *et al.* [NA48 Collab.], *Phys. Lett. B* **514**, 253 (2001).
  37. F. Bossi, these proceedings.
  38. A. J. Buras, M. E. Lautenbacher, M. Misiak and M. Munz, *Nucl. Phys. B* **423**, 349 (1994) [arXiv:hep-ph/9402347].
  39. L. M. Sehgal, *Phys. Rev. D* **38**, 808 (1988); G. Ecker, A. Pich and E. de Rafael, *Phys. Lett. B* **237**, 481 (1990); L. Cappiello, G. D'Ambrosio and M. Miragliuolo, *Phys. Lett. B* **298**, 423 (1993); P. Heiliger and L.M. Sehgal, *Phys. Rev. D* **47**, 4920 (1993); A G. Cohen, G. Ecker and A. Pich, *Phys.*

- Lett. B* **304**, 347 (1993); J.F. Donoghue and F. Gabbiani, *Phys. Rev. D* **51**, 2187 (1995) [arXiv:hep-ph/9408390]; G. D'Ambrosio and J. Portolés, *Nucl. Phys. B* **492**, 417 (1997) [arXiv:hep-ph/9610244].
40. A. Alavi-Harati *et al.* [KTeV Collab.], *Phys. Rev. Lett.* **86**, 397 (2001) [arXiv:hep-ex/0009030].
  41. G. Valencia, *Nucl. Phys. B* **517**, 339 (1998) [arXiv:hep-ph/9711377]; G. Dumm and A. Pich, *Phys. Rev. Lett.* **80**, 4633 (1998) [arXiv:hep-ph/980129].
  42. D. Ambrose *et al.* [E871 Collab.], *Phys. Rev. Lett.* **84**, 1389 (2000).
  43. D. E. Groom *et al.* [Particle Data Group], *Eur. Phys. J. C* **15**, 1 (2000).
  44. L. Bergstrom, E. Masso and P. Singer, *Phys. Lett. B* **249**, 141 (1990).
  45. G. D'Ambrosio, G. Isidori and J. Portolés, *Phys. Lett. B* **423**, 385 (1998) [arXiv:hep-ph/9708326].
  46. A. Alavi-Harati *et al.* [KTeV Collab.], *Phys. Rev. Lett.* **87**, 071801 (2001).
  47. For a recent review see e.g.: T. Hurth, arXiv:hep-ph/0106050; A. J. Buras, arXiv:hep-ph/0101336.
  48. M. Wise, these proceedings.
  49. G. Isidori, arXiv:hep-ph/0101121.
  50. S. Bertolini, F. Borzumati, A. Masiero, *Phys. Rev. Lett.* **59**, 180 (1987); N. G. Deshpande *et al.*, *Phys. Rev. Lett.* **59**, 183 (1987).
  51. K. Adel and Y. P. Yao, *Phys. Rev. D* **49**, 4945 (1994) [arXiv:hep-ph/9308349].
  52. C. Greub, T. Hurth and D. Wyler, *Phys. Lett. B* **380**, 385 (1996) [arXiv:hep-ph/9602281]; *Phys. Rev. D* **54**, 3350 (1996) [arXiv:hep-ph/9603404].
  53. C. Greub and T. Hurth, *Phys. Rev. D* **56**, 2934 (1997) [arXiv:hep-ph/9703349].
  54. A. J. Buras, A. Czarnecki, M. Misiak and J. Urban, *Nucl. Phys. B* **611**, 488 (2001) [arXiv:hep-ph/0105160].
  55. K. Chetyrkin, M. Misiak and M. Munz, *Phys. Lett. B* **400**, 206 (1997); **425**, 414 (1997) (E) [arXiv:hep-ph/9612313].
  56. P. Gambino and U. Haisch, arXiv:hep-ph/0109058; *JHEP* **0009**, 001 (2000) [arXiv:hep-ph/0007259]; A. Strumia, *Nucl. Phys. B* **532**, 28 (1998) [arXiv:hep-ph/9804274]. A. Czarnecki and W. J. Marciano, *Phys. Rev. Lett.* **81**, 277 (1998) [arXiv:hep-ph/9804252].
  57. M. Ciuchini, G. Degrassi, P. Gambino and G. F. Giudice, *Nucl. Phys. B* **527**, 21 (1998) [arXiv:hep-ph/9710335]. F. M. Borzumati and C. Greub, *Phys. Rev. D* **58**, 074004 (1998) [arXiv:hep-ph/9802391].
  58. M. Ciuchini, G. Degrassi, P. Gambino and G. F. Giudice, *Nucl. Phys. B* **534**, 3 (1998) [arXiv:hep-ph/9806308]; C. Bobeth, M. Misiak and J. Urban, *Nucl. Phys. B* **567**, 153 (2000) [arXiv:hep-ph/9904413].
  59. G. Degrassi, P. Gambino, G. F. Giudice, *JHEP* **0012**, 009 (2000) [arXiv:hep-ph/0009337]; M. Carena, D. Garcia, U. Nierste and C. E. Wagner, *Phys. Lett. B* **499**, 141 (2001) [arXiv:hep-ph/0010003].
  60. M. Misiak, *Nucl. Phys. B* **393**, 23 (1993); **439**, 461 (1993) (E); A. J. Buras and M. Munz, *Phys. Rev. D* **52**, 186 (1995) [arXiv:hep-ph/9501281].
  61. C. Bobeth, M. Misiak and J. Urban, *Nucl. Phys. B* **574**, 291 (2000) [arXiv:hep-ph/9910220]; H.H. Asatrian, H.M. Asatrian, C. Greub and M. Walker, *Phys. Lett. B* **507**, 162 (2001) [arXiv:hep-ph/0103087]; arXiv:hep-ph/0109140.
  62. R. Barate *et al.* [ALEPH Collab.], *Eur. Phys. J. C* **19**, 213 (2001) [arXiv:hep-ex/0010022].
  63. Y. Grossman, Z. Ligeti and E. Nardi, *Nucl. Phys. B* **465**, 369 (1996); **480**, 753 (1996) (E) [arXiv:hep-ph/9510378].
  64. A. Ali, H. Asatrian and C. Greub, *Phys. Lett. B* **429**, 87 (1998) [arXiv:hep-ph/9803314].
  65. D. Cassel, these proceedings; S. Chen

- et al.* [CLEO Collab.], arXiv:hep-ex/0108032.
66. H. Tajima, these proceedings. K. Abe *et al.* [BELLE Collab.], *Phys. Lett. B* **511**, 151 (2001) [arXiv:hep-ex/0103042].
  67. A.F. Falk, M. Luke and M.J. Savage, *Phys. Rev. D* **49**, 3367 (1994) [arXiv:hep-ph/9308288].
  68. M. B. Voloshin, *Phys. Lett. B* **397**, 275 (1997) [arXiv:hep-ph/9612483]; A. Grant, A. Morgan, S. Nussinov and R. Peccei, *Phys. Rev. D* **56**, 3151 (1997) [arXiv:hep-ph/9702380].
  69. Z. Ligeti, L. J. Randall and M. B. Wise, *Phys. Lett. B* **402**, 178 (1997) [arXiv:hep-ph/9702322].
  70. G. Buchalla, G. Isidori and S. J. Rey, *Nucl. Phys. B* **511**, 594 (1998) [arXiv:hep-ph/9705253].
  71. A. L. Kagan and M. Neubert, *Eur. Phys. J. C* **7**, 5 (1999) [arXiv:hep-ph/9805303].
  72. P. Gambino and M. Misiak, *Nucl. Phys. B* **611**, 338 (2001) [arXiv:hep-ph/0104034].
  73. See T. Besmer, C. Greub and T. Hurth, *Nucl. Phys. B* **609**, 359 (2001) [arXiv:hep-ph/0105292] and references therein.
  74. R. Barbieri, G. Cacciapaglia and A. Romito, arXiv:hep-ph/0107148.
  75. A. L. Kagan and M. Neubert, *Phys. Rev. D* **58**, 094012 (1998) [arXiv:hep-ph/9803368].
  76. T. E. Coan *et al.* [CLEO Collab.], *Phys. Rev. Lett.* **86**, 5661 (2001) [arXiv:hep-ex/0010075].
  77. B. Grinstein and D. Pirjol, *Phys. Rev. D* **62**, 093002 (2000) [arXiv:hep-ph/0002216].
  78. A. Ali and A. Y. Parkhomenko, arXiv:hep-ph/0105302.
  79. M. Beneke, T. Feldmann and D. Seidel, *Nucl. Phys. B* **612**, 25 (2001) [arXiv:hep-ph/0106067].
  80. S. W. Bosch and G. Buchalla, arXiv:hep-ph/0106081.
  81. J. M. Soares, *Nucl. Phys. B* **367**, 575 (1991); T. Hurth and T. Mannel, *Phys. Lett. B* **511**, 196 (2001) [arXiv:hep-ph/0103331].
  82. K. Abe *et al.* [BELLE Collab.], arXiv:hep-ex/0109026.
  83. B. Aubert *et al.* [BABAR Collab.], arXiv:hep-ex/0107026.
  84. A. Ali, G. Hiller, L. T. Handoko and T. Morozumi, *Phys. Rev. D* **55**, 4105 (1997) [arXiv:hep-ph/9609449].
  85. G. Buchalla and G. Isidori, *Nucl. Phys. B* **525**, 333 (1998) [arXiv:hep-ph/9801456].
  86. F. Krüger and L.M. Sehgal, *Phys. Lett. B* **380**, 199 (1996) [arXiv:hep-ph/9603237].
  87. A. Ali, G. F. Giudice and T. Mannel, *Z. Phys. C* **67**, 417 (1995) [arXiv:hep-ph/9408213].
  88. E. Lunghi, A. Masiero, I. Scimemi and L. Silvestrini, *Nucl. Phys. B* **568**, 120 (2000).
  89. A. Ali, P. Ball, L. T. Handoko and G. Hiller, *Phys. Rev. D* **61**, 074024 (2000) [arXiv:hep-ph/9910221]; E. Lunghi and I. Scimemi, *Nucl. Phys. B* **574**, 43 (2000) [arXiv:hep-ph/9912430]; F. Krüger and J.C. Romão, *Phys. Rev. D* **62**, 034020 (2000). [arXiv:hep-ph/0002089]; Q. Yan, C. Huang, W. Liao and S. Zhu, *Phys. Rev. D* **62**, 094023 (2000) [arXiv:hep-ph/0004262].
  90. G. Buchalla, G. Hiller and G. Isidori, *Phys. Rev. D* **63**, 014015 (2001) [arXiv:hep-ph/0006136].
  91. G. Burdman, *Phys. Rev. D* **57**, 4254 (1998) [arXiv:hep-ph/9710550].
  92. F. Abe *et al.* [CDF Collab.], *Phys. Rev. D* **57**, 3811 (1998).
  93. K. S. Babu and C. Kolda, *Phys. Rev. Lett.* **84**, 228 (2000) [arXiv:hep-ph/9909476];
  94. C. S. Huang, W. Liao, Q. S. Yan and S. H. Zhu, *Phys. Rev. D* **63**,

- 114021 (2001); **64**, 059902 (2001) (E) [arXiv:hep-ph/0006250]. P. H. Chankowski and L. Slawianowska, *Phys. Rev. D* **63**, 054012 (2001) [arXiv:hep-ph/0008046]. C. Bobeth, T. Ewerth, F. Kruger and J. Urban, *Phys. Rev. D* **64**, 074014 (2001) [arXiv:hep-ph/0104284].
95. A. Dedes, H. K. Dreiner and U. Nierste, arXiv:hep-ph/0108037; G. Isidori and A. Retico, arXiv:hep-ph/0110121.
96. See e.g.: G. Burdman, arXiv:hep-ph/9811457; G. Burdman, E. Golowich, J. L. Hewett and S. Pakvasa, *Phys. Rev. D* **52** (1995) 6383 [arXiv:hep-ph/9502329].
97. S. Fajfer, S. Prelovsek and P. Singer, arXiv:hep-ph/0106333; S. Fajfer, P. Singer and J. Zupan, *Phys. Rev. D* **64**, 074008 (2001) [arXiv:hep-ph/0104236]; S. Fajfer, S. Prelovsek, P. Singer and D. Wyler, *Phys. Lett. B* **487**, 81 (2000) [arXiv:hep-ph/0006054].
98. D. Ambrose *et al.* [E871 Collab.], *Phys. Rev. Lett.* **81**, 5734 (1998) [arXiv:hep-ex/9811038].
99. D. F. Carvalho, J. R. Ellis, M. E. Gomez and S. Lola, *Phys. Lett. B* **515**, 323 (2001) [arXiv:hep-ph/0103256]; A. Belyaev *et al.*, arXiv:hep-ph/0008276.